







CL.1 Concealed two-way diverter - Chrome

CL.1

36 202 705

- rotary diverter
- rosette 60 x 60 mm



	Chrome	36 202 705-00
	Brushed Platinum	36 202 705-06
	Dark Chrome	36 202 705-19
	Brushed Champagne (22kt Gold)	36 202 705-46
	Champagne (22kt Gold)	36 202 705-47
	Brushed Dark Platinum	36 202 705-99

Required miscellaneous



- Concealed two-way diverter -** 35 202 970 90
- max. recess depth 160 mm
 - min. recess depth 115 mm

36 202 705

mm [inches]

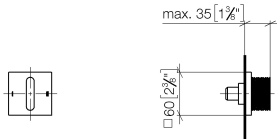

Flow rate chart

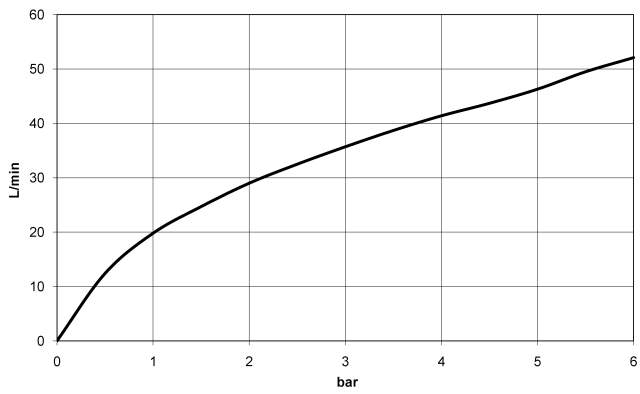

Certificates

LGA_38379.

WRAS_2307045.

36 202 705

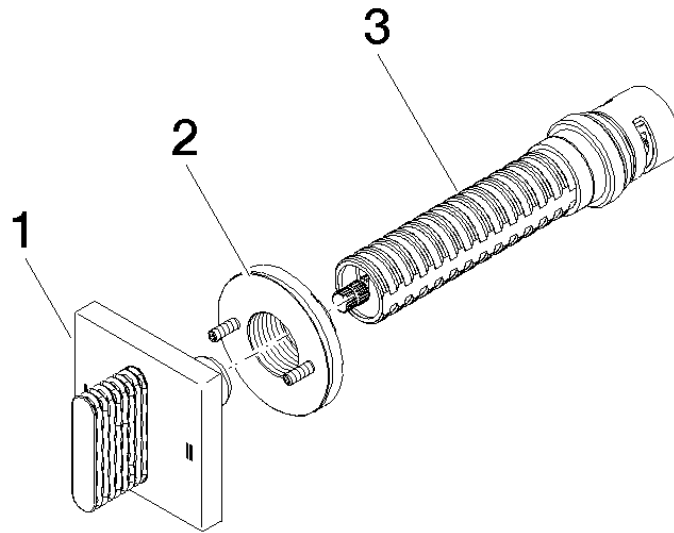

Spare parts list

No.	Item Number	Name	Quantity used	Delivery time
1	90 20 70 053 08-00	handle	1	10
2	90 21 02 181 00 90	disc	1	2
3	90 90 03 304 10 90	diverter	1	2